

# FULL HD

## Vehicle Video Recorder

### User Manual

---



GPS / GPS Option

2014 MAY V1.0

---



---

## Safety Precautions

---

Please Take and review some testing videos initially to make sure the images were recorded correctly.

Please note that manufacturer, its subsidiaries and affiliates, and its distributors are not liable for consequential damages arising from any malfunction of main device accessory, including memory device that results in the failure of an image to be recorded or to be recorded in a way that is machine readable.

Before using the product, please ensure that you read the safety precautions described below. Always ensure that the product is used correctly.

- Use only recommended power sources.
- Do not attempt to disassemble, alter or apply heat to the product.
- DO NOT apply multi cigarette lighter adapters-Applying such devices will cause unstable power input to damage the vehicle video recorder.
- Please always make sure all power connectors are fully secured.
- Avoid dropping or subjecting the product to severe impacts.
- To avoid the risk of injury, do not touch the interior of the product if it has been dropped or otherwise damaged.
- Stop using the product immediately if it emits smoke, a strange smell, or otherwise behaves abnormally.
- Do not use organic solvents such as alcohol, benzene, or thinner to clean the product.

- Do not let the product come into contact with water (e.g. sea water) or other liquids.
- Do not allow liquids or foreign objects to enter the VVR.
- Do not place the VVR near or in direct flame.
- Do not handle the power cord with wet hands.
- Do not use the equipment in a manner that exceeds the rated capacity of the electrical outlet or wiring accessories.
- Do not use if the power cord or plug are damaged, or not fully plugged into the outlet.
- Do not allow dirt or metal objects (such as pins or keys) to contact the terminals or plug.
- Avoid using, placing or storing the product in the humid or dusty areas.

---

# Index

---

A. ACCESSORIES.....	1
B. FEATURE DESCRIPTION .....	2
C. SPECIFICATIONS.....	3
D. INSTALLATION .....	4
E. CONTROL PANEL / FUNCTION BOARD.....	6
F. SD CARD INSTALLATION .....	8
G. RECORD AND STOP .....	9
H. REMOTE CONTROL.....	10
I. OSD MENU FUNCTION.....	11
J. VACRON VIEWER .....	12
K. RECORD TIME ESTIMATION.....	23
L. CRITERIA OF TFT LCD INSPECTION .....	24
APPENDIX – EXCEPTION CLAUSE .....	25

## **A. ACCESSORIES**

Please review the contents prior to use. Please contact your local dealer if something not found in the box.

※ Storage card is not included in the box as free provision.

- Standard

- Cigar Lighter Adapter / Bracket / Software CD / Bracket / Remote Control / Quick User Guide

- Optional

- 4G / 8G / 16G / 32G Class10 or above SDHC Card

## **B. FEATURE DESCRIPTION**

- Full HD Real-time recorder of H.264 Codec
- 105° Wide-angle CMOS Sensor
- 2.5" TFT LCD
- Records video and audio of a car around
- SDHC Card in Use
- Loop recording / on start recording
- Manual Record Events Not Overwritten
- G-Sensor Built in Crash Event Saved Securely
- GPS and Image data are recorded and playable on client software.
- Made In Taiwan Three Years Warranty

## C. SPECIFICATIONS

Item	Description
Sensor	CMOS Sensor
Resolution	Full-HD ; NTSC 1080P 30fps / PAL 1080P 25fps
Power Supply	DC5V±5% / 1 Amp.
Operating Tmp.	-10°C~ +60°C
Storage	SDHC Card Recommended SanDisk Class 10or above 4GB at least
Recording	Prompt recording when power on stop recording when power off
Recording Data	Date/Time/Video/Audio/G-Sensor/GSP
Storage Format	Specific file play via PC player and play on DVR
Audio Input	Built-in microphone
Time setting	Built-in permanent calendar with adjustable function through remote control or bundled Player.
G-Sensor	Built-in 3D G-Sensor

### GPS Model

GPS	Speed / Coordinate / Calibration
Google Map	Driving Route

※ Storage card is not included in the box as free provision.

※ Specifications shall be changed subject to necessary update

## D. INSTALLATION

1. Install the device on the windshield by “Stick-Holder” type

Sticker Adhesive Spot

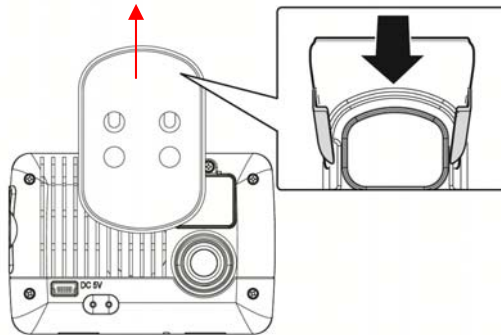

2. The best position to install the device on the windshield

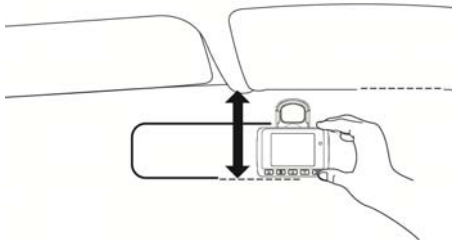

3. Adjust the view angle properly

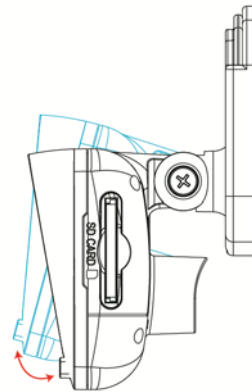

4. Plug in DC5V Power Supply

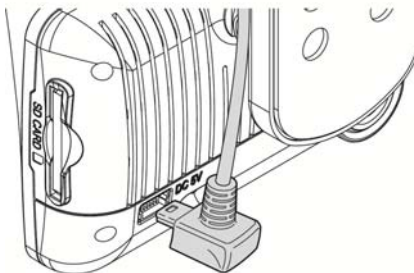

5. Plug in the Cigarette Charger

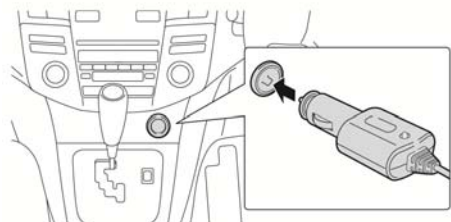



## 6. VVR Installation

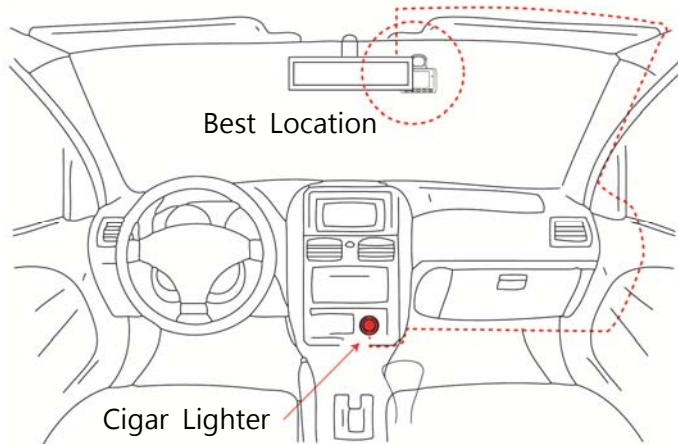

### Precautions

- (a) This device should be installed in the windshield of clean and dry.
- (b) Formatting SD card on the device before beginning to use.
- (c) The best location must be in the range of the moving wipes.
- (d) Format the memory card in the DVR prior the very first recording.
- (e) Set time zone and timing on OSD.OSD.
- (f) NTSC or PAL setting through OSD.NTSC
- (g) GPS Mouse performance should be affected by window film more or less.

## E. CONTROL PANEL / FUNCTION BOARD

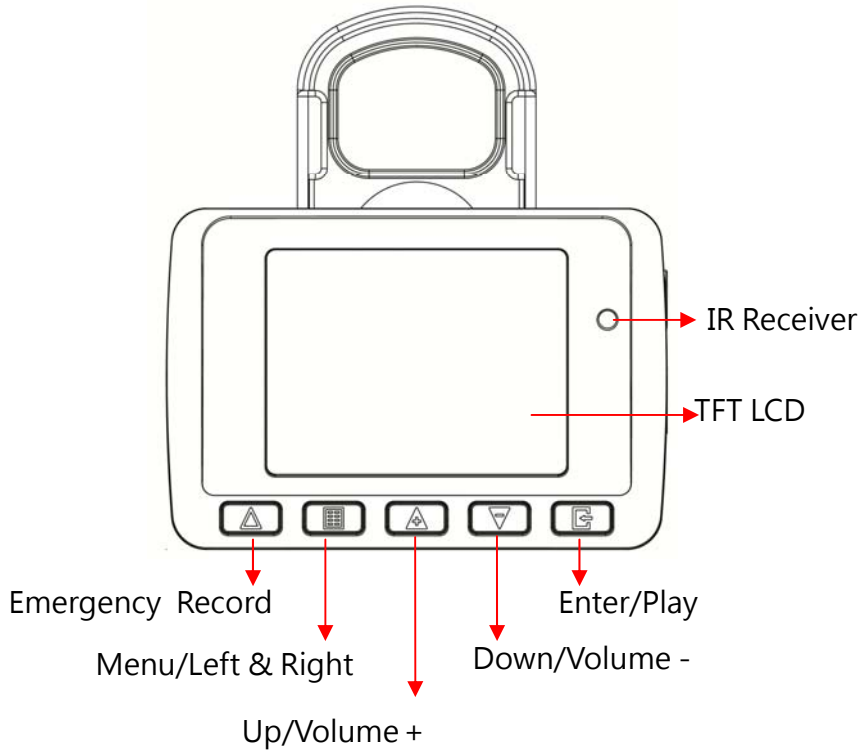

- Emergency Record is a priority button. Whenever Emergency Record occurs record status comes up to the screen.

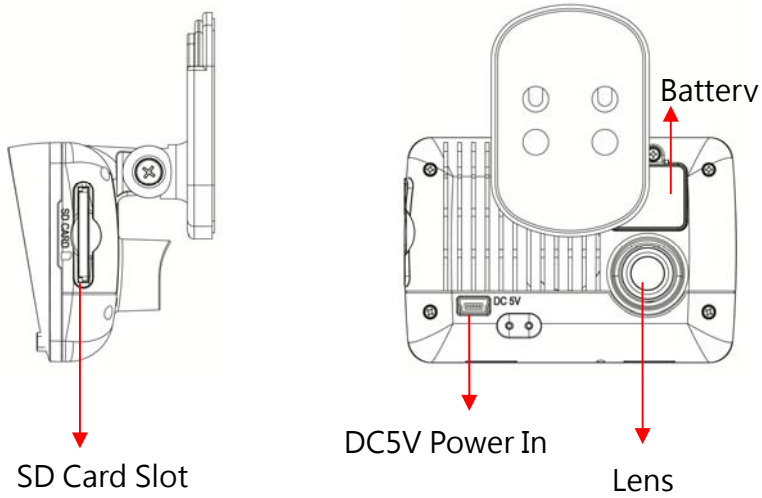

Size of VVR

unit : mm

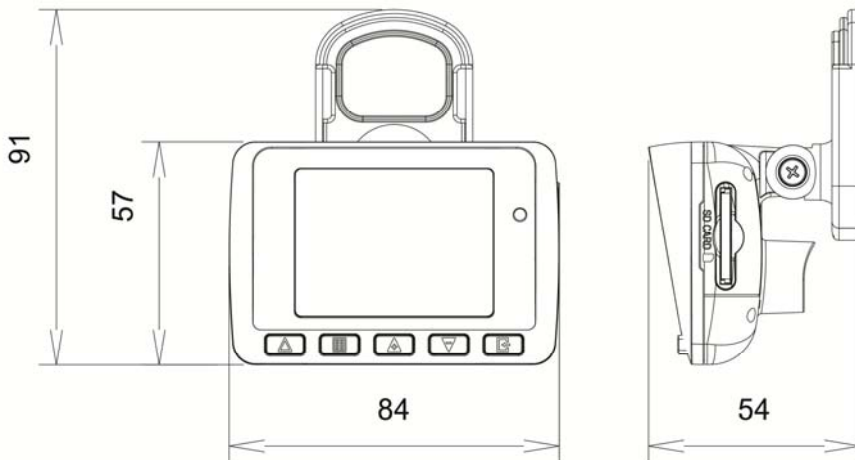

## F. SD CARD INSTALLATION

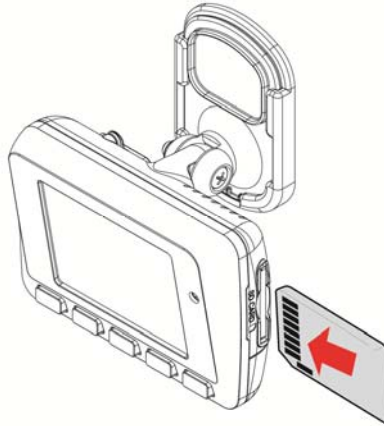

- (1). Please read other pages for detailed information of SD card format.

Reminder – SD card is not free provision from manufacturer.



### **CAUTION**

- (1). Recommended SanDisk Class 10 or above 4GB at least
- (2). If the memory card is not formatted by the player, the device will automatically erase all the data.
- (3). Please DO NOT use Micro SD card adaptor. The adaptor could be cause of trouble recording.
- (4). Memory card has its limit on written times. Better use PC player to playback the files inside the card periodically.

## **G. RECORD AND STOP**

### **1. Reboot/Record**

Reboot the DVR system ready in 30 seconds. DVR starts recording.

### **2. Power Off/Stop**

Power off DVR stops recording. Files in the storage can be reviewed on PC.

### **3. Indicator**

**Red** – Recording blinks ( Emergency blinks frequently )

**Blue** - GPS (Not Positioned – Blinks / Positioned – Always Blue)

**Green** – Night Mode Shimmering Light



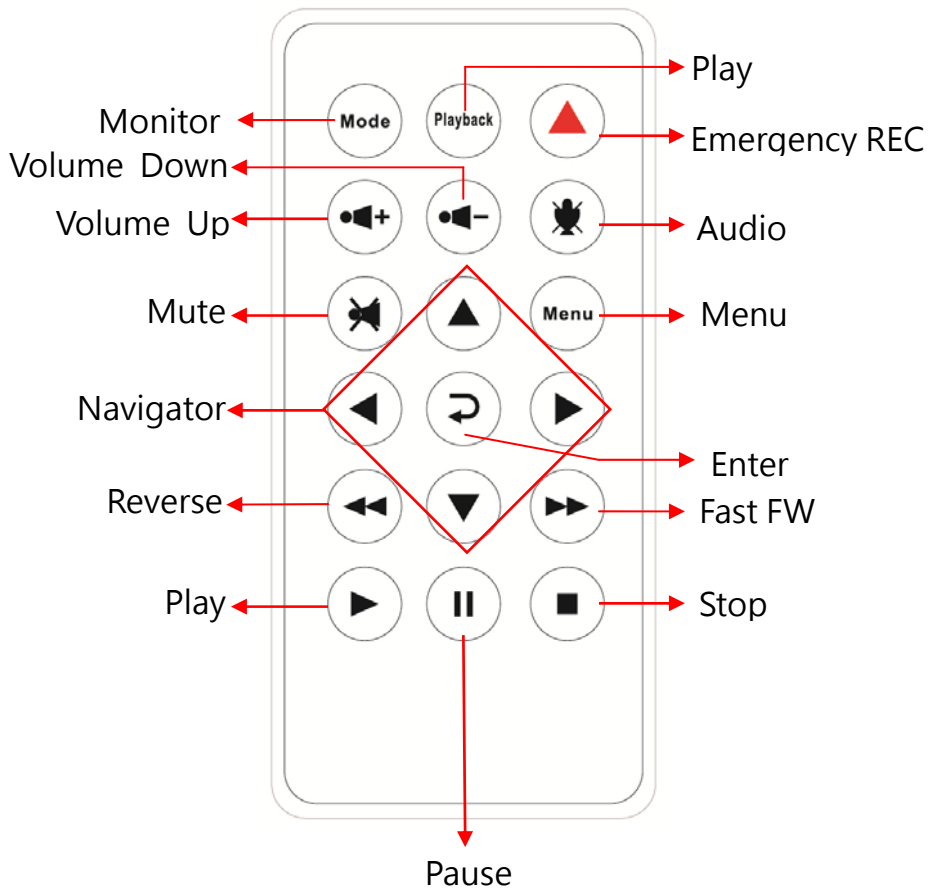

## H. REMOTE CONTROL

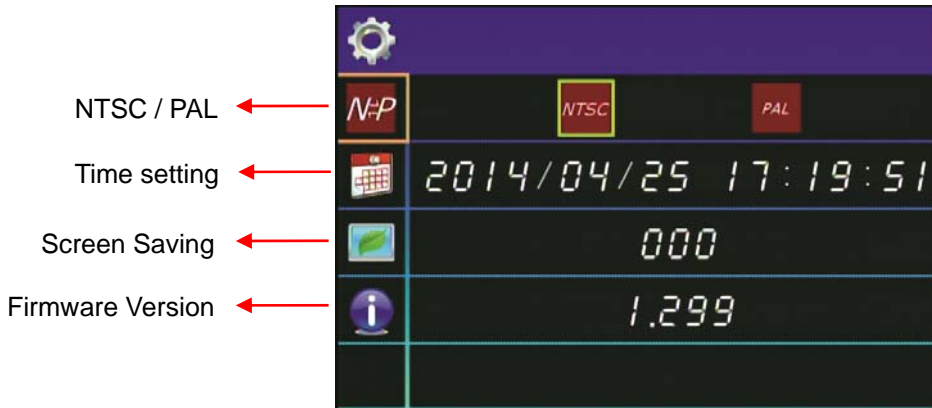

## I. OSD MENU FUNCTION

Select Menu enter OSD as below









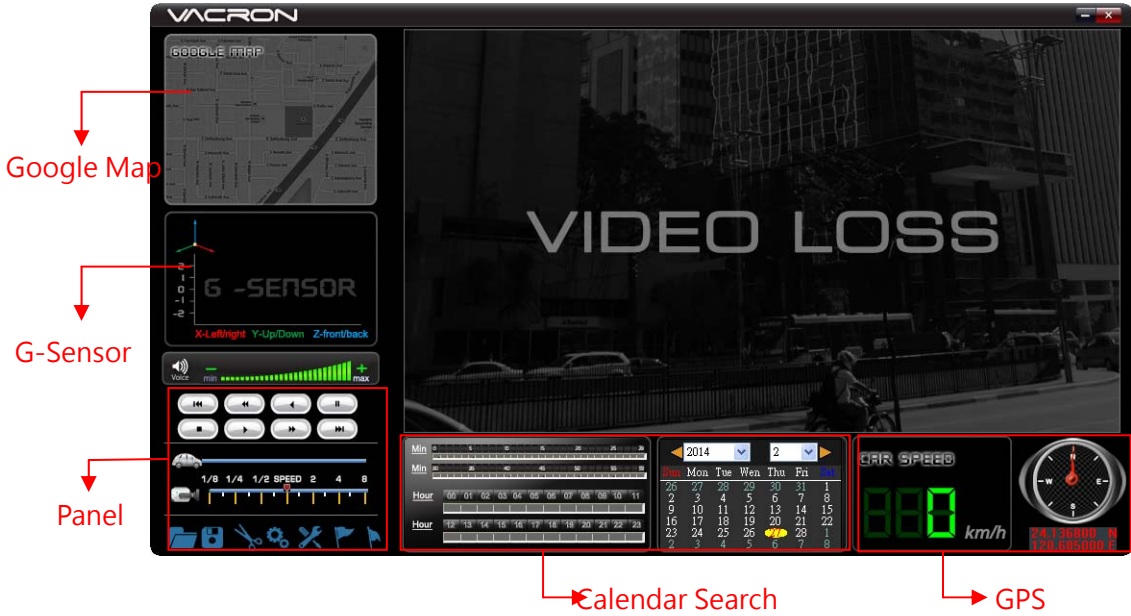

1. Select  to setup NTSC or PAL
2. Select  to setup calendar
3. Select  to setup screensaver
4. Select  to review version

## J. VACRON VIEWER



★ Reminder- DirectX 9.0 is required



### 1. Control Panel

	Previous File
	Previous Frame
	Reverse
	Pause
	Stop
	Play
	Next Frame
	Next File



2.  Snapshot – take a picture of the video. Select  the default path comes out file name saved as .bmp.

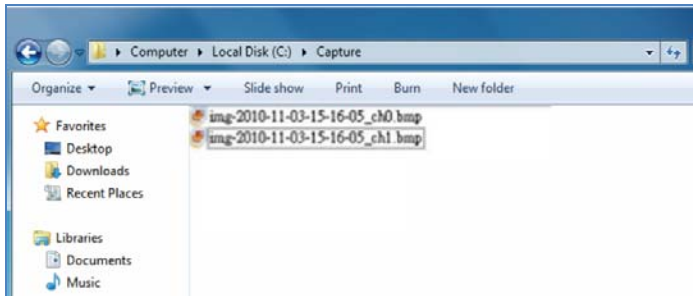

Files

3.  Playback video open file

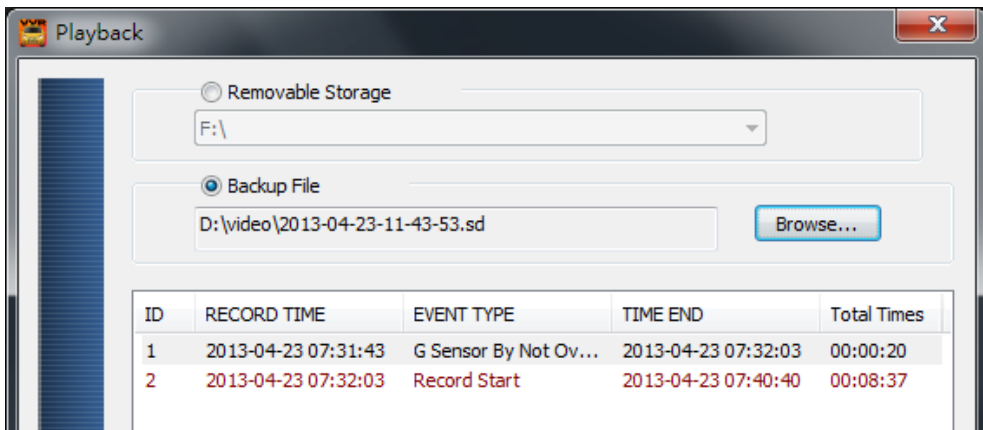

#### 4. Format Tool can format storage

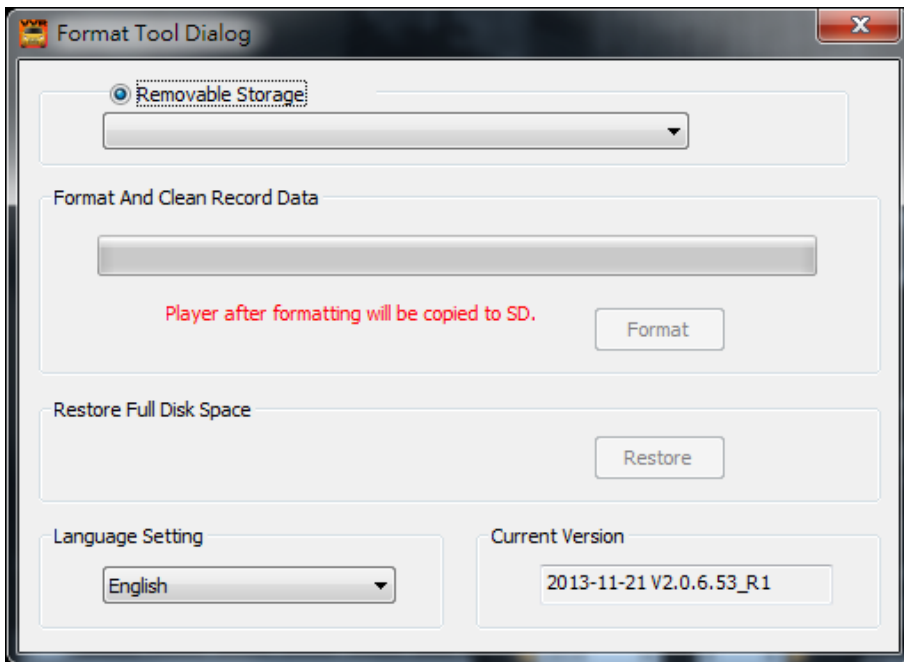

### Precautions

- (1). 「Format / Restore」 will clean all the data saved on SD card, Please back up the data before 「Format / Restore」.
- (2) Before 「Format / Restore」 SD memory card, please ensure to unlock it first.
- (1). If the card is unlocked but still cannot be formatted, this might be caused by Window Vista / 7 security restrictions. Please run the program as Administrator to prevent from this problem.

- a、 「Format」 SD card

While applying a brand new SD card, formatting is required.

- b、 「Restore」 SD card

When you have backup the recorded files into PC and want to use the SDHC card for other purposes, you have to restore it first so it can be used correctly.

- c、 Language setting

**Select the designated the display language.**

\* Note: New language setting will start after rebooting.

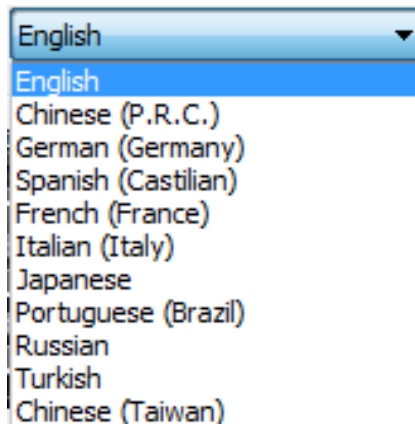

- d、 Current Version

Version Support VACRON web site <http://vvr.vacron.com>

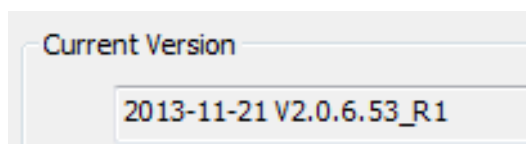

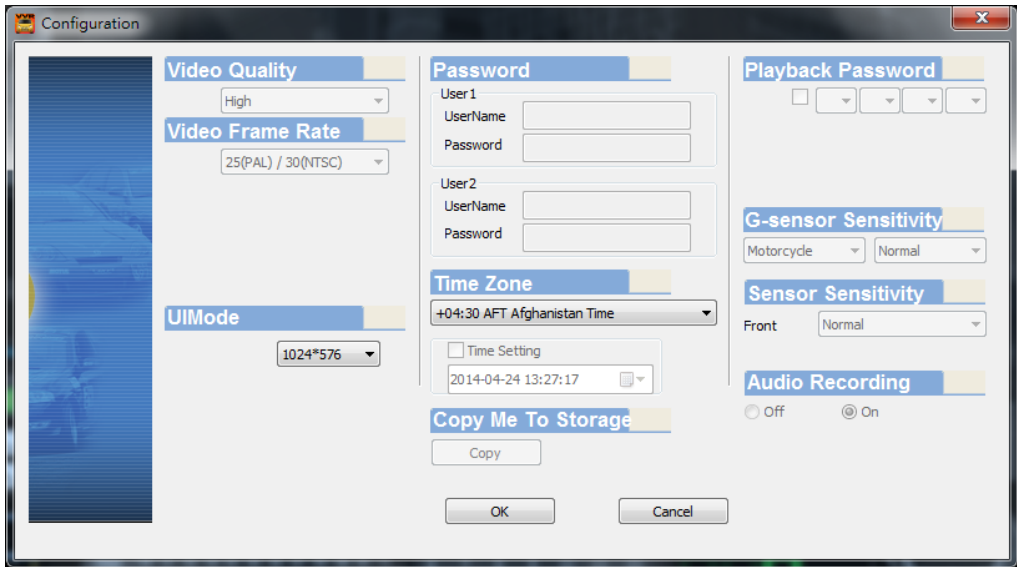

5.  Configuration: configure default setting

Put the SD Card into Card reader and plug-in the card reader into the USB slot of your PC to format the SD card before the first time to record. Then also need to configure video type and display way, when finish the setting, insert the SD card the vehicle video recorder to start recording.

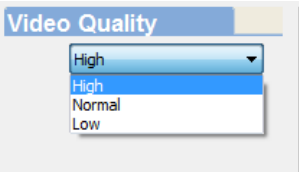
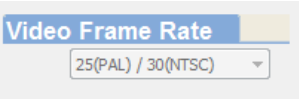
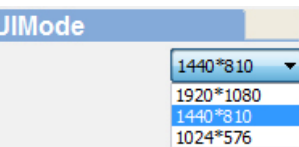

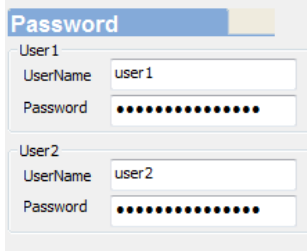
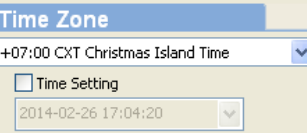
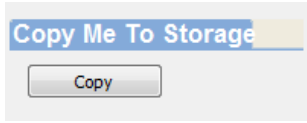
1	Image quality		The default quality is high / Normal / Low
2	fps setting		25(PAL) / 30(NTSC)
3	UI Mode		The resolution can be adjusted.

4	Password		<p>This function can encrypt the SD card to prevent illegal retrieving from others, the password is under 15 character, for example:123456789123456</p> <p>You will need input password when you playback/configuration/format SD card if you set a password.</p> <p>★ Note: Upper/lower character is different; remember the password is very important.</p>
5	Time Zone		Adjust Time by GMT
6	Copy Me to Storage		Copy the player to SD card.
7	Password in LCD playing		You can set the password, when playback on the device LCD, you need to unlock

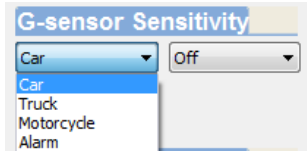
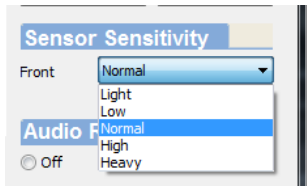
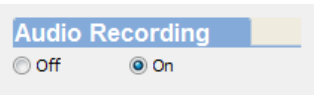
			the password.
8	G-sensor sensitivity		Vehicle type and G-Sensor' s sensitivity can be adjusted.
9	Sensor Sensitivity		According to night conditions set sensitivity. The night sensitivity settings for lens: Light / Low / Normal / High / Heavy.
10	Audio recording		Audio recording on/off

6.  File backup: click to choose file save directory.

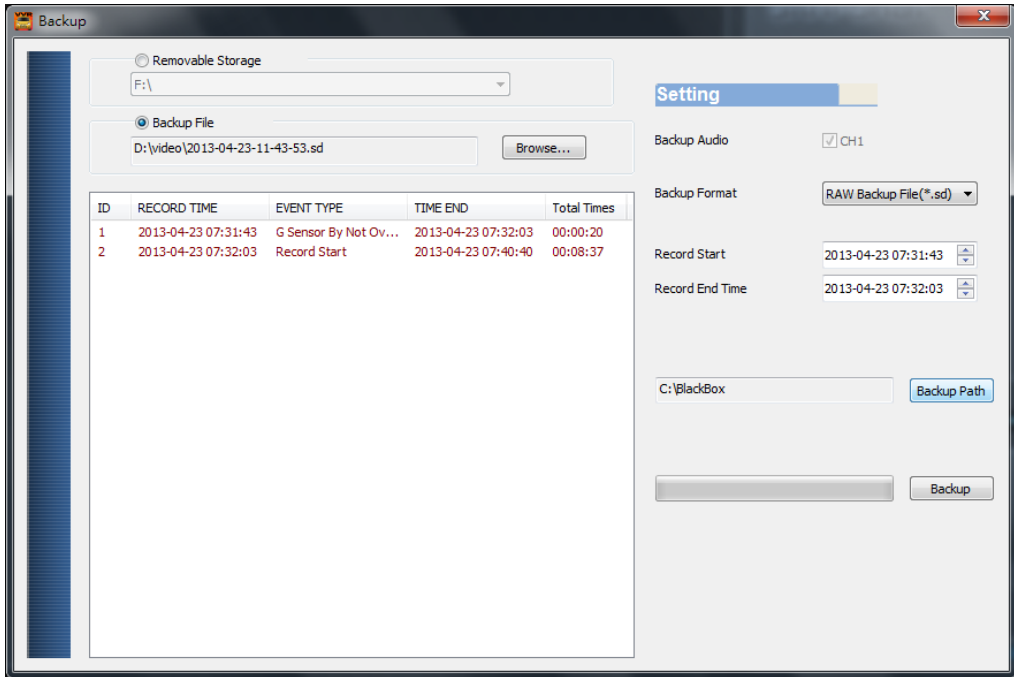

Step1. Choose the source of the memory card.

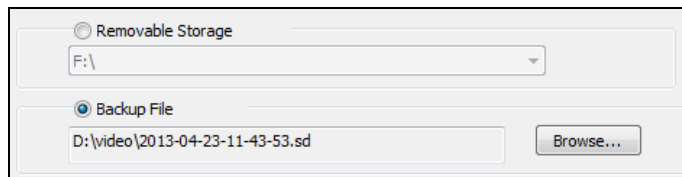

Step2. Choose the designated footage to backup.

ID	RECORD TIME	EVENT TYPE	TIME END	Total Times
1	2013-04-23 07:31:43	G Sensor By Not Ov...	2013-04-23 07:32:03	00:00:20
2	2013-04-23 07:32:03	Record Start	2013-04-23 07:40:40	00:08:37

Step3. Choose the target file format and start/end record time.

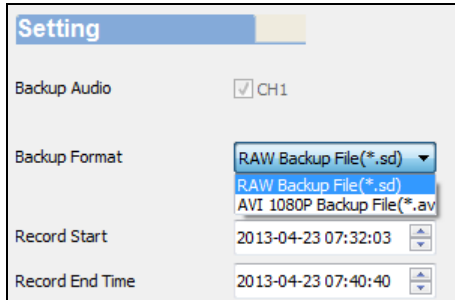

### File format

(1) Our original file format

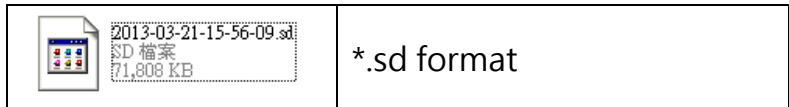

(2)AVI File Backup(\*.avi)

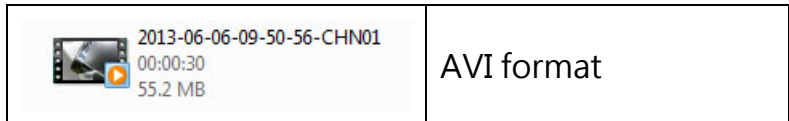

★ Note: G-sensor data can only be displayed on manufacturer' s player.



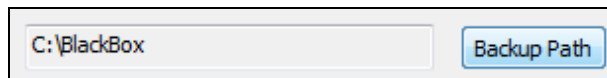

Step 4. Set the backup folder: default is C:\BlackBox

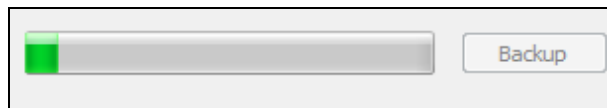

Step 5. Start to backup





7.   Flag backup  Start  End and select  to select backup range.
8. Play BAR: You can use Mouse to drag the car icon to move video location.



9. Play speed: 4X \ 8X \ 16X and quick playback, 1/4X \ 1/8X \ 1/16X and slow playback.



10. Volume control: Click + \ - to adjust volume.



## 11. G-SENSOR

G-Sensor will detect the impact from the car, and record 1-3 minutes video automatically. This footage will save to separate area to avoid file from being overwritten.



(1) **X** : Detect vehicle horizontal change.

(2) **Y** : Detect vehicle vertical change.

(3) **Z** : Detect vehicle front/back change.

## K. RECORD TIME ESTIMATION

The chart below is for reference only. The length of time recorded can be varied due to variation in image size may be different.

Capacity Quality	8GB	16GB	32GB
High	120 Minutes	240 Minutes	480 Minutes

## L. CRITERIA OF TFT LCD INSPECTION

Q: What is bright spot? What is dark spot?

A: • Bright Spot: At dark background, we found the abnormal bright spots, we called those spot are "Bright Spot"

- Dark Spot: At multiple color background (excluded dark background), we found the abnormal dark spot, those spots are "Dark Spots"

Q: Criteria of bright spot

- No bright spot in zone A and only one dark spot here.
- 2 bright spots is OK in zone B same standard to dark spot.
- Totally 3 Bright spot plus dark spot is OK in zone A+B.

1/4	1/2	1/4	
B	B	B	1/4
B	A	B	1/2
B	B	B	1/4

Zone A and Zone B



### Precautions

- 30 days return policy against Criteria of TFT LCD Inspection.
- You can get the replacement from your local dealer within 30 days from the receipt date.
- Only 30 days validity and RMA not included.
- Light emitting components are weaker time by time. Changes on brightness, color and ghost image are in tolerance range.

## APPENDIX – EXCEPTION CLAUSE

Fuho Technology Co., Ltd. states exception clause to reserve the rights of the exclusive warranty and product liability hereafter.

1. Users do not follow the proper installation stated in user manual.
2. Not authorized repair agent gets the DVR damaged.
3. Damaged out of abnormal operation.
4. Damaged out of abnormal surroundings.
5. Damaged out of natural disaster or force majeure.
6. Damaged out of delivery by unauthorized dealers.
7. Damaged out of illegal software or components.
8. Invalid serial number or no number.
9. Noise from other products.
10. Damaged out of strong impact.

Applicable law and jurisdiction court

Explanation, application and other not stated should be regulated by the law of Republic of China. The jurisdiction of the first trial is the district court of Chang Hua, Taiwan.



---

For more information  
Please visit VACRON website  
<http://vvr.vacron.com>

Made in Taiwan

---